



Ruckus Wireless™ SmartCell Gateway™ 200

S2a Interface Reference Guide for SmartZone 3.4.1

Part Number 800-71359-001 Rev A
Published October 2016

www.ruckuswireless.com

Copyright Notice and Proprietary Information

Copyright 2016 Ruckus Wireless, Inc. All rights reserved.

No part of this documentation may be used, reproduced, transmitted, or translated, in any form or by any means, electronic, mechanical, manual, optical, or otherwise, without prior written permission of Ruckus Wireless, Inc. ("Ruckus"), or as expressly provided by under license from Ruckus.

Destination Control Statement

Technical data contained in this publication may be subject to the export control laws of the United States of America. Disclosure to nationals of other countries contrary to United States law is prohibited. It is the reader's responsibility to determine the applicable regulations and to comply with them.

Disclaimer

THIS DOCUMENTATION AND ALL INFORMATION CONTAINED HEREIN ("MATERIAL") IS PROVIDED FOR GENERAL INFORMATION PURPOSES ONLY. RUCKUS AND ITS LICENSORS MAKE NO WARRANTY OF ANY KIND, EXPRESS OR IMPLIED, WITH REGARD TO THE MATERIAL, INCLUDING, BUT NOT LIMITED TO, THE IMPLIED WARRANTIES OF MERCHANTABILITY, NON-INFRINGEMENT AND FITNESS FOR A PARTICULAR PURPOSE, OR THAT THE MATERIAL IS ERROR-FREE, ACCURATE OR RELIABLE. RUCKUS RESERVES THE RIGHT TO MAKE CHANGES OR UPDATES TO THE MATERIAL AT ANY TIME.

Limitation of Liability

IN NO EVENT SHALL RUCKUS BE LIABLE FOR ANY DIRECT, INDIRECT, INCIDENTAL, SPECIAL OR CONSEQUENTIAL DAMAGES, OR DAMAGES FOR LOSS OF PROFITS, REVENUE, DATA OR USE, INCURRED BY YOU OR ANY THIRD PARTY, WHETHER IN AN ACTION IN CONTRACT OR TORT, ARISING FROM YOUR ACCESS TO, OR USE OF, THE MATERIAL.

Trademarks

Ruckus Wireless, Ruckus, the bark logo, ZoneFlex, FlexMaster, ZoneDirector, SmartMesh, Channelfly, Smartcell, Dynamic PSK, and Simply Better Wireless are trademarks of Ruckus Wireless, Inc. in the United States and other countries. All other product or company names may be trademarks of their respective owners

Contents

About This Guide

Document Conventions	6
Terminology	6
References	8
Legend	8
Related Documentation	8
Online Training Resources	8
Documentation Feedback	9

1 Data Session and Path Management Messages

Overview	11
Data Session Establishment	13
Path Management Messages	14

2 Tunnel Management Messages

Create Session Process Flow	16
Create Session Request Messages	16
Bearer Context - Create Session Request	18
Create Session Response Messages	18
Bearer Context - Create Session Response Messages	20
Modify Bearer Command Flow	20
Bearer Context - Modify Bearer	21
Modify Bearer Request Flow	21
Modify Bearer Request Messages	22
Bearer Context - Modify Bearer Request Messages	22
Modify Bearer Response Message	23
Bearer Context - Modify Bearer Response Messages	23
Update Bearer Process Flow	24
Update Bearer Request Messages	24
Bearer Context - Update Bearer Request Messages	25
Update Bearer Response Message	25
Bearer Context - Update Bearer Response Message	25
Delete Bearer Process Flow	26

Delete Bearer Request Messages	26
Delete Bearer Response Messages	27
Bearer Context - Delete bearer response messages	27
Delete Session Process Flow	27
Delete Session Request Message	28
Delete Session Response Message	28

Index

About This Guide

This *SmartCell Gateway™ (SCG) 200 S2a Interface Reference Guide* describes the interface between the SCG and the Packet Data Network Gateway (PDN-GW). It also describes the control plane GPRS (General Packet Radio Service) tunneling protocol messages.

This guide is written for service operators and system administrators who are responsible for managing, configuring, and troubleshooting Ruckus Wireless devices. Consequently, it assumes a basic working knowledge of local area networks, wireless networking, and wireless devices.

NOTE If release notes are shipped with your product and the information there differs from the information in this guide, follow the instructions in the release notes.

Most user guides and release notes are available in Adobe Acrobat Reader Portable Document Format (PDF) or HTML on the Ruckus Wireless Support Web site at <https://support.ruckuswireless.com/contact-us>.

Document Conventions

Table 1 and Table 2 list the text and notice conventions that are used throughout this guide.

Table 1. Text conventions

Convention	Description	Example
monospace	Represents information as it appears on screen	[Device name] >
monospace bold	Represents information that you enter	[Device name] > set ipaddr 10.0.0.12
default font bold	Keyboard keys, software buttons, and field names	On the Start menu, click All Programs .
<i>italics</i>	Screen or page names	Click Advanced Settings . The <i>Advanced Settings</i> page appears.

Table 2. Notice conventions

Notice Type	Description
NOTE	Information that describes important features or instructions
CAUTION!	Information that alerts you to potential loss of data or potential damage to an application, system, or device
WARNING!	Information that alerts you to potential personal injury

Terminology

Table 3 lists the terms used in this guide.

Table 3. Terms used in this guide

Terminology	Description
AAA	Authentication, Authorization, and Accounting
AMBR	Aggregate Maximum Bit Rate
APN	Access Point Name
DNS	Domain Name System
EBI	EPS Bearer ID

Table 3. Terms used in this guide

Terminology	Description
EPC	Evolved Packet Core
EPS	Evolved Packet System
F-TEID	Fully Qualified Tunnel Endpoint Identifier
GPDU	GTP Packet Data Unit
GPRS	General Packet Radio Service
GSN APN	GPRS serving node, is application module in the SCG handling GTP messages
GTP	GPRS Tunneling Protocol
GTPv1-U	GTP version 1, user plane
GTPv2-C	GTP version 2, control plane
IE	Information Element
IMSI	International Mobile Subscriber Identity
IP	Internet Protocol
MCC	Mobile Country Code
MNC	Mobile Network Code
MSISDN	Mobile Subscriber ISDN Number
PAA	PDN Address Allocation
PCO	Protocol Configuration Options
PDN	Packet Data Network
PGW	PDN Gateway
SGW	Serving Gateway
ULI	User Location Information
UMTS	Universal Mobile Telecommunications Systems
UTRAN	UMTS Terrestrial Radio Access Network

References

Table 4 lists the references used in this guide.

Table 4. References used

Serial Number	Reference	Description
1	29274-b20.docx	<ul style="list-style-type: none"> • 3GPP TS 29.274 V11.2.0 (2012-03) 3GPP Evolved Packet System (EPS) • Evolved General Packet Radio Service (GPRS) • Tunneling Protocol for Control plane (GTPv2-C) • Stage 3 (Release 11)

Legend

Table 5 lists the legend/presence used in this guide.

Table 5. Legend/presence used in this guide

Legend/Presence/ Value	Description
C	Conditional
Instance Value	The Instance Value column indicates the instance number of the IE, which is used in differentiating between two instances of same IE, i.e., IE with the same type in the same message.
M	Mandatory
O	Optional

Related Documentation

For a complete list of documents that accompany this release, refer to the Release Notes.

Online Training Resources

To access a variety of online Ruckus Wireless training modules, including free introductory courses to wireless networking essentials, site surveys, and Ruckus Wireless products, visit the Ruckus Wireless Training Portal at: <https://training.ruckuswireless.com>

Documentation Feedback

Ruckus Wireless is interested in improving its documentation and welcomes your comments and suggestions. You can email your comments to Ruckus Wireless at:

docs@ruckuswireless.com

When contacting us, please include the following information:

- Document title
- Document part number (on the cover page)
- Page number (if appropriate)

For example:

- SCG™ 200 S2a Interface Reference Guide for SmartZone 3.4.1
- Part number: 800-71359-001
- Page 15

Data Session and Path Management Messages

1

In this chapter:

- [Overview](#)
- [Data Session Establishment](#)
- [Path Management Messages](#)

Overview

This reference guide describes the interface between the SmartCell Gateway (SCG) with Packet Data Network Gateway (PDN-GW). It describes the control plane GPRS (General Packet Radio Service) tunneling protocol messages v2 for EPS (Evolved Packet System) interfaces (GTPv2-C) from the SCG and PGW. This guide lists all the interface messages and GPRS Tunneling Protocol (GTP-C) information element used between the SCG and PGW.

The S2a interface is used in control signaling between the SCG and PDN-GW (Packet Data Network Gateway) as well as for tunneling end user data payload within the backbone network between both the nodes in EPC (Evolved Packet Core) network.

The GPRS Tunneling Protocol (GTP) transmits user data packets and signaling messages between the SCG and PDN-GW. GTP encapsulates traffic and creates GTP tunnels, which acts as virtual data channels for transmission of packet data between the SCG and PDN-GW. A GTP tunnel is established between the SCG and PDN-GW through *Create Session Request* procedure for a data session initiated from UE.

The SCG acts as trusted non-3GPP access network (TWAN) towards PDN-GW with S2a (GTPv2) interface. In case the operator EPC network does not support the S2a interface, the SCG can be statically configured to support S5 (GTPv2) interface, in which case the SCG acts as Serving Gateway (SGW).

A GTP tunnel is identified by a pair of IP addresses and a pair of GTP Tunnel End Point Identifiers (TEIDs), where one IP address and TEID is for the SCG (TWAN) and the other is for the PGW. The TEID is a session identifier used by GTP protocol entities in the SCG and in the PGW. GTP separates signaling from payload. Traffic is sorted onto a control plane (GTP-C) for signaling and a user plane (GTP-U) for user data. GTP-C is a tunnel control and management protocol and is used to create, modify and delete tunnels. GTP-U is a tunneling mechanism, which provides a service for carrying user data packets. On both planes, a GTP header encapsulates the data packet, called GTP Packet Data Unit (GPDU), and a path implemented by UDP/IP is used as bearer of the GTP traffic. [Figure 1](#) shows the deployment of the SCG in operator networks with 3G and EPC.

Figure 1. Deployment of SCG with 3G and EPC

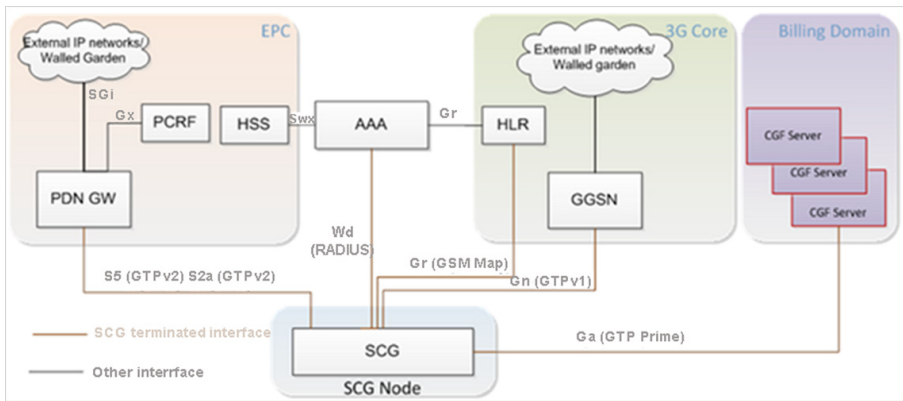

The SCG supports the following categories of GTP signaling traffic:

- Path Management Messages: The main purpose of these messages is to supervise an UDP/IP path to ensure that connectivity failure can be detected on time. This is managed by frequently sending GTP Echo or Echo response packets between SCG and PGW.
- Tunnel Management Messages: These contain messages that establish, modify and release GTP tunnels.

NOTE: The SCG support for STA interface is being considered for the future release.

NOTE: Refer to [About This Guide](#) for the conventions used in this guide.

Data Session Establishment

Figure 2 depicts session establishment based on the session such as create, modify, update and so on.

Figure 2. Data session establishment

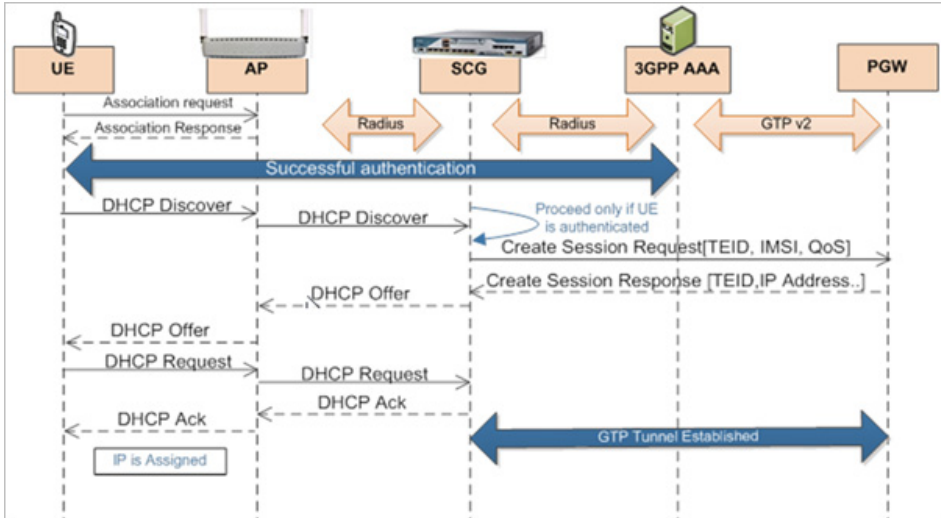

Path Management Messages

Path management messages, monitors the health of the transport between GTP-C peers, which is the SCG and PGW. [Figure 3](#) shows the path management messages process flow and [Table 6](#) lists the attribute.

NOTE: GSN APP is GPRS serving node which is an application module in the SCG for handling GTP messages.

Figure 3. Path management messages

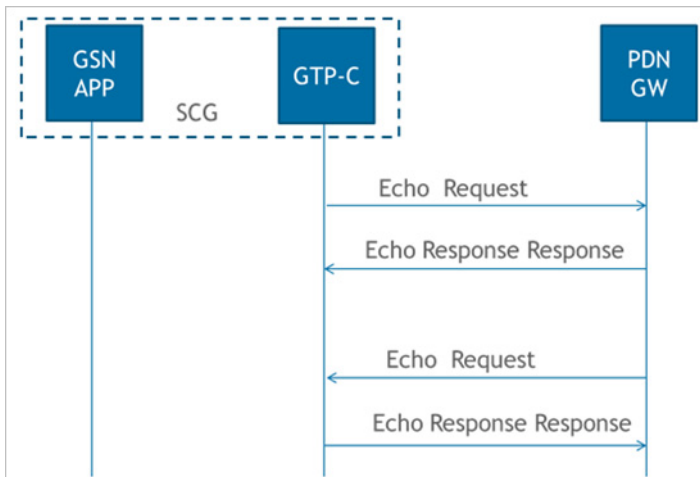

Table 6. Echo request message

Attribute	Presence	Comment
Recovery	M	SCG/PGW updates the local restart counter in this IE

Tunnel Management Messages

2

In this chapter:

- [Create Session Process Flow](#)
- [Modify Bearer Command Flow](#)
- [Modify Bearer Request Flow](#)
- [Update Bearer Process Flow](#)
- [Delete Bearer Process Flow](#)
- [Delete Session Process Flow](#)

Tunnel management messages, manages the tunnel between GTP-C peers, which includes create, update, modify and delete procedures.

Create Session Process Flow

Figure 4 shows the process flow for create session. This section covers:

- [Create Session Request Messages](#)
- [Create Session Response Messages](#)

Figure 4. Create session

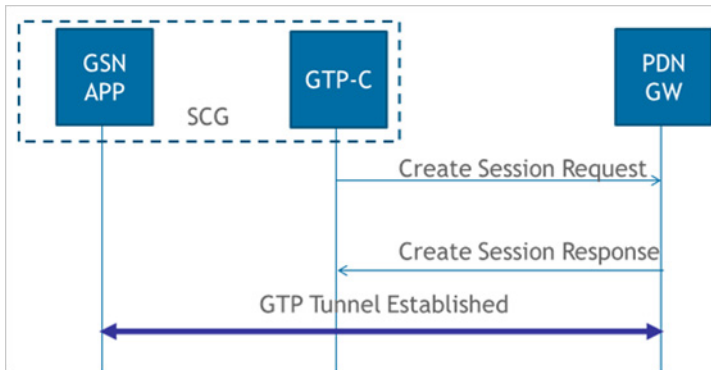

Create Session Request Messages

Table 7 lists the create session request messages attributes. This section covers:

- [Bearer Context - Modify Bearer](#)

NOTE: The Instance Value column indicates the instance number of the IE, which is used in differentiating between two instances of same IE, i.e., IE with the same type in the same message.

Table 7. Create session - request messages

Attribute	Instance Value	Presence	Interface (S2a, S5 Both)	Description
IMSI	0	C	Both	IMSI of the subscriber.
MSISDN	0	C	Both	MSISDN received from HLR or AAA server during authentication.

Table 7. Create session - request messages (Continued)

Attribute	Instance Value	Presence	Interface (S2a, S5 Both)	Description
Serving Network	0	C	Both	MCC and MNC as configured in the SCG web interface. This attribute will not be present if it is not configured in the SCG web interface.
RAT Type	0	M	Both	For S5 interface value is 6 (EUTRAN) and for S2a interface the value is 3 (WLAN).
Indication	0	C	Both	Value is set to zero.
F-TEID	0	M	S2a	Sender F-TEID for control plane, SCG generated TEID
F-TEID	1	M	S5	Sender F-TEID for control plane, SCG generated TEID
APN	0	M	Both	Access Point Name (APN), APN NI+OI
Selection Mode	0	C	Both	The value shall be set to "MS or network provided APN, subscription verified"
PDN Type	0	C	S5	Set to IPV4
PAA	0	C	Both	PDN Address allocation, set to 0.0.0.0
AMBR	0	C	Both	Aggregate Maximum Bit Rate (APN-AMBR), configurable in ttg_pdg.cfg
Bearer Context		M	Both	Bearer context is created
Recovery	0	C	Both	This attribute is included if its contacting the peer node for the first time
Charging Characteristics	0	C	Both	Mandatory in case of SCG, CC received form HLR/HSS or default value in SCG if not received form external entity
Maximum APN Restriction	0	C	S5	Value is set to zero, this value is set to the least restrictive type
User Location Information (ULI)	0	C	S5	User Location Information (ULI), MCC MNC from UE realm

Bearer Context - Create Session Request

Table 8 lists the attributes of bearer context for create session request messages.

Table 8. Bearer context - request messages

Attribute	Instance Value	Presence	Interface	Description
EBI	0	M	Both	EPS Bearer ID
Bearer QoS	0	M	Both	Bearer Level QoS
F-TEID	2	C	S5	S5-U SGW F-TEID
F-TEID	6	C	S2a	S2a-U TWAN F-TEID

Create Session Response Messages

Table 9 lists the attribute for create session response messages. This section covers:

- [Bearer Context - Create Session Response Messages](#)

Table 9. Create session response message

Attribute	Instance Value	Presence	Interface (S2a, S5, Both)	Description
Cause	0	M	Both	Cause in response message.
Change Reporting Action	0	C	S5	
F-TEID	1	C	Both	Includes the TEID in the GTP based interfaces
PAA	0	C	Both	PDN Address Allocation
APN Restriction	0	C	S5	APN restriction
AMBR	0	C	Both	Aggregate Maximum Bit Rate (APN-AMBR), is included only if the received APN-AMBR is modified by the PCRF.
Charging Gateway Address	0	O	S5	PGW may include CGF IP address provided the CGF server IP address is configured in the user interface. The SCG sets this server with highest priority, for sending generated GDR's.
Bearer Context	0	M	Both	Includes the QoS, Charging ID along with other attributes

Table 9. Create session response message (Continued)

Attribute	Instance Value	Presence	Interface (S2a, S5, Both)	Description
Recovery	0	C	Both	Included only if the peer node is contacted for the first time.
FQDN	0	C	S5	Charging gateway name
IP Address	0	C	S5	Charging gateway address
Protocol Configuration Options (PCO)	0	O	S2a	PGW could include this IE on the S2a interface to provide TWAN with additional IP configuration parameters (example, DNS server). This IE is included provided a corresponding request is received in the Create Session - request message.
EPC Timer	0	O	S5	PGW Back-Off Time, PDN-GW rejects the Create Session Request with the cause "APN congestion". It indicates the time during which the peer should refrain from sending subsequent PDN connection establishment requests to the PGW for the congested APN for services other than Service Users/emergency services. <i>Note:</i> Not supported in this release
IPv4 Configuration Parameters (IP4CP)	0	CO	S2a	Trusted WLAN IPv4 Parameters <i>Note:</i> Not supported in this release
Private Extension	0	O	Both	Private Extension <i>Note:</i> Not supported in this release

Bearer Context - Create Session Response Messages

Table 10 lists the bearer context attributes for create session response messages.

Table 10. Bearer context for create session response messages

Attribute	Instance Value	Presence	Interface (S2a, S5, Both)	Description
Cause	0	M	Both	Cause in response message.
EBI	0	M	Both	EPS Bearer ID
Bearer QoS	0	C	Both	Bearer Level QoS
TFT	0	O	Both	Bearer modification and TFT change
F-TEID	2	C	S5	S5-U PGW F-TEID
F-TEID	5	C	S2a	S2a-U PGWF-TEID
Charging ID	0	O	Both	Charging ID
Bearer Flag	0	O	S5	Bearer flag

Modify Bearer Command Flow

Figure 5 shows the modify bearer process flow. Table 11 lists the modify bearer attributes. This section covers:

- [Bearer Context - Modify Bearer](#)

Figure 5. Modify bearer

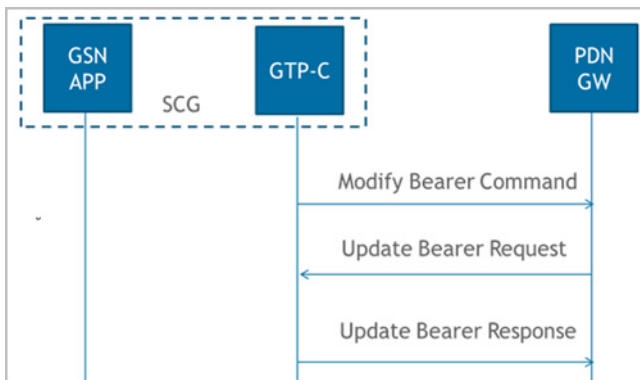

Table 11. Modify bearer

Attribute	Instance Value	Presence	Interface (S2a, S5, Both)	Description
Bearer Context	0	M	Both	Modified bearer context
AMBR	0	M	Both	Aggregate Maximum Bit Rate (APN-AMBR)

Bearer Context - Modify Bearer

Table 12 lists the attributes of bearer context.

Table 12. Bearer context - Modify bearer

Attribute	Instance Value	Presence	Interface (S2a, S5, Both)	Description
EBI	0	M	Both	EPS Bearer ID
Bearer QoS	0	C	Both	Bearer Level QoS

Modify Bearer Request Flow

Figure 6 shows the bearer process flow of request and response messages, when modified. This section covers:

- [Modify Bearer Request Messages](#)
- [Modify Bearer Response Message](#)

Figure 6. Modify bearer request and response messages

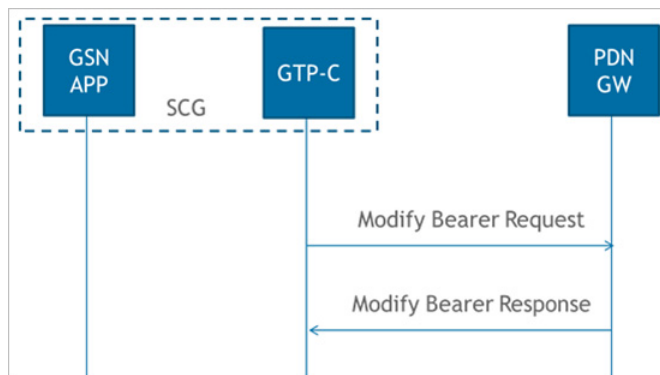

Modify Bearer Request Messages

Table 13 lists the attributes of modified bearer request messages. This section covers:

- [Modify Bearer Request Messages](#)

Table 13. Modify bearer request messages

Attribute	Instance Value	Presence	Interface (S2a, S5, Both)	Description
ULI	0	C	S5	User Location Information
Serving Network	0	C	S5	Serving network
RAT Type	0	C	Both	For S5 the interface value is 6 (EUTRAN) and for S2a interface the value is 3 (WLAN).
Indication	0		Both	Indication flags
F-TEID	0		Both	Sender F-TEID for control plane
Bearer Context	0	C	Both	Bearer Contexts to be modified
Recovery	0	C	Both	Included only if the peer node is contacted for the first time.

NOTE: In release 11 specifications, *Modify Bearer Request* is not supported in an S2a interface. To support roaming scenarios Ruckus Wireless assumes that this message is required for S2a interface. Ruckus Wireless will continue with this implementation until 3GPP specification has proper roaming scenarios for S2a interface.

Bearer Context - Modify Bearer Request Messages

Table 14 lists the attributes of bearer context request messages for modify bearer.

Table 14. Bearer context - Modify bearer request messages

Attribute	Instance Value	Presence	Interface (S2a, S5, Both)	Description
EBI	0	M	Both	EPS Bearer ID
TEID	1	C	Both	Data Plane TEID

Modify Bearer Response Message

Table 15 lists the modified bearer response messages. This section covers:

- [Bearer Context - Modify Bearer Response Messages](#)

Table 15. Modify bearer response messages

Attribute	Instance Value	Presence	Interface (S2a, S5, Both)	Description
Cause	0	M	Both	Possible causes could be: <ul style="list-style-type: none"> • Request accepted • Request accepted partially • Context not found • Service not supported
MSISDN	0	C	Both	MSISDN
EBI	0	C	Both	Linked EPS Bearer ID
AMBR	0	C	Both	Aggregate Maximum Bit Rate (APN-AMBR), is included only if the received APN-AMBR is modified by the PCRF
Bearer Context	0	M	Both	Bearer contexts modified
Change Reporting Action	0	C	Both	
Recovery	0	C	Both	Included only if the peer node is contacted for the first time.

Bearer Context - Modify Bearer Response Messages

Table 16 lists the attributes of bearer context response messages for modify bearer.

Table 16. Bearer context - Modify bearer response messages

Attribute	Instance Value	Presence	Interface (S2a, S5, Both)	Description
EBI	0	M	Both	EPS Bearer ID
Cause	0	M	Both	Cause
Charging ID	0	O	S5	Charging ID

Update Bearer Process Flow

Figure 7 shows the bearer process flow, when updated. This section covers:

- [Update Bearer Request Messages](#)
- [Update Bearer Response Message](#)

Figure 7. Update Bearer

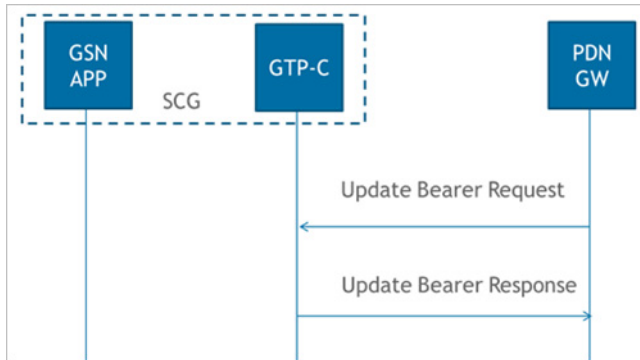

Update Bearer Request Messages

Table 17 lists the update bearer request messages. This section covers:

- [Bearer Context - Update Bearer Request Messages](#)

Table 17. Update bearer request messages

Attribute	Instance Value	Presence	Interface (S2a, S5, Both)	Description
Bearer Context	0	M	Both	Modified bearer context
PCO	0	C	S5	Protocol Configuration Option
AMBR	0	C	Both	Aggregate Maximum Bit Rate (APN-AMBR)
Private Extension	0	O	Both	Private extension

Bearer Context - Update Bearer Request Messages

Table 18 lists the attributes of bearer context for update bearer request messages.

Table 18. Bearer context - Update bearer request messages

Attribute	Presence	Interface (S2a, S5, Both)	Description
EBI	M	Both	EPS Bearer ID
Bearer QoS	C	Both	Bearer level QoS
TFT	C	Both	Bearer modification and change
PCO	CO	S5	Protocol Configuration Option

Update Bearer Response Message

Table 19 lists the update bearer response messages. This section covers:

- [Bearer Context - Update Bearer Response Message](#)

Table 19. Update bearer response messages

Attribute	Presence	Interface (S2a, S5, Both)	Description
Cause	M	Both	Cause value
Bearer Context	O	Both	Failed bearer context
Recovery	C	Both	Included only if the peer node is contacted for the first time.
PCO	C/O	S5	Protocol Configuration Options (PCO) contains PCO from HLR or PCO received from PDN-GW in Create Session Response

Bearer Context - Update Bearer Response Message

Table 20 lists the attributes of bearer context for update bearer response message.

Table 20. Bearer context - Update bearer response messages

Attribute	Instance Value	Presence	Interface (S2a, S5, Both)	Description
EBI	0	M	Both	EPS Bearer ID
Cause	0	M	Both	Indicates if the bearer handling was successful and if not successful, displays the reasons

Table 20. Bearer context - Update bearer response messages

Attribute	Instance Value	Presence	Interface (S2a, S5, Both)	Description
PCO	0	CO	S5	Protocol Configuration Options (PCO) contains PCO from HLR or PCO received from PDN-GW in Create Session Response

Delete Bearer Process Flow

Figure 8 shows the bearer process flow, when updated. This section covers:

- [Delete Bearer Request Messages](#)
- [Delete Bearer Response Messages](#)

Figure 8. Delete bearer

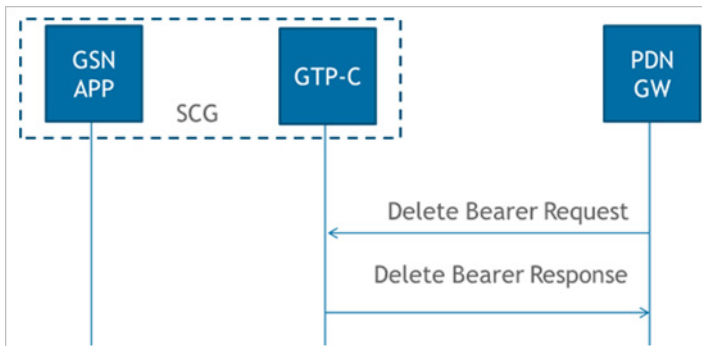

Delete Bearer Request Messages

Table 21 lists the delete bearer request messages.

Table 21. Delete bearer request messages

Attribute	Instance Value	Presence	Interface (S2a, S5, Both)	Description
EBI	0	C	Both	Linked EPS Bearer ID (LBI)
EBI	1	C	Both	EPS Bearer IDs
Bearer Context	0	O	S5	Failed bearer context
PCO	0	C	S5	Protocol Configuration Options (PCO)

Delete Bearer Response Messages

Table 22 lists the delete bearer response message attributes. This section covers:

- [Bearer Context - Delete bearer response messages](#)

Table 22. Delete bearer response messages

Attribute	Instance Value	Presence	Interface (S2a, S5, Both)	Description
Cause	0	M	Both	Cause value
EBI	0	C	Both	Linked EPS Bearer ID (LBI)
Bearer Context	0	O	Both	Considers it as a failed bearer context when SCG fails to delete the bearer
Recovery	0	C	Both	Included only if the peer node is contacted for the first time.

Bearer Context - Delete bearer response messages

Table 23 lists the attributes of delete bearer context.

Table 23. Bearer context - Delete bearer response messages

Attributes	Instance Value	Presence	Interface (S2a, S5, Both)	Description
EBI	0	M	Both	EPS Bearer ID (LBI)
Cause	0	M	Both	Indicates if the bearer handling was successful. If it is not successful, the reason is displayed.

Delete Session Process Flow

This section covers:

- [Delete Session Request Message](#)
- [Delete Session Response Message](#)

Delete Session Request Message

Table 24 lists the attribute for delete session request message.

Table 24. Delete session request messages

Attribute	Instance Value	Presence	Interface (S2a, S5, Both)	Description
EBI	0	C	Both	Linked EPS Bearer ID (LBI)

Delete Session Response Message

Table 25 lists the delete session response message attributes.

Table 25. Delete session response messages

Attribute	Instance Value	Presence	Interface (S2a, S5, Both)	Description
Cause	0	M	Both	Cause value
Recovery	0	C	Both	Included only if the peer node is contacted for the first time.
Private Extension	0	O	Both	Private extension

Index

A

AMBR 17, 18, 21, 23, 24
APN 17
APN restriction 18

B

bearer context 17, 18, 21, 22, 23, 24, 26, 27
bearer context - create session request 18
bearer context - create session response messages 20
bearer context - delete bearer response messages 27
bearer context - modify bearer 21
bearer context - modify bearer response messages 23
bearer context - update bearer response message 25
bearer context update bearer request message 25
bearer flag 20
bearer QoS 18, 20, 21, 25

C

cause 18, 20, 23, 25, 27, 28
change reporting action 18, 23
charging characteristics 17
charging gateway address 18
charging ID 20, 23
create session 16
create session request messages 16
create session response messages 18

D

data session establishment 13
delete bearer 26
delete bearer request messages 26
delete bearer response messages 27
delete session 27
delete session response message 28

E

EBI 18, 20, 21, 22, 23, 25, 26, 27, 28
EPC 11
EPC Timer 19
EPS 11

F

FQDN 19
F-TEID 17, 18, 20, 22

G

GPDU 11
GPRS 11
GTP-C 11
GTP-U 11
GTPv2-C 11

I

IMSI 16
indication 17, 22
IP Address 19
IP4CP 19

M

maximum APN restriction 17
modify bearer 21
modify bearer process flow 20
modify bearer request 22
modify bearer request messages 22
modify bearer response message 23
MSISDN 16, 23

P

PAA 17, 18
packet data network gateway 11
path management messages 12
PCO 19, 24, 25, 26
PDN Type 17
private extension 19, 24, 28

R

RAT Type 17, 22
recovery 14, 17, 19, 22, 23, 27, 28

S

S2a interface 11
selection mode 17
Serving Gateway 11
serving network 17, 22

T

TEID 11, 22
TFT 20, 25
tunnel management messages 12
TWAN 11

U

ULI 17, 22
update bearer 24
update bearer request message 24
update bearer response message 25



Copyright © 2006-2016. Ruckus Wireless, Inc.
350 West Java Dr. Sunnyvale, CA 94089. USA
www.ruckuswireless.com